

DIAMOND TECH INTERNATIONAL
Innovations For Creativity

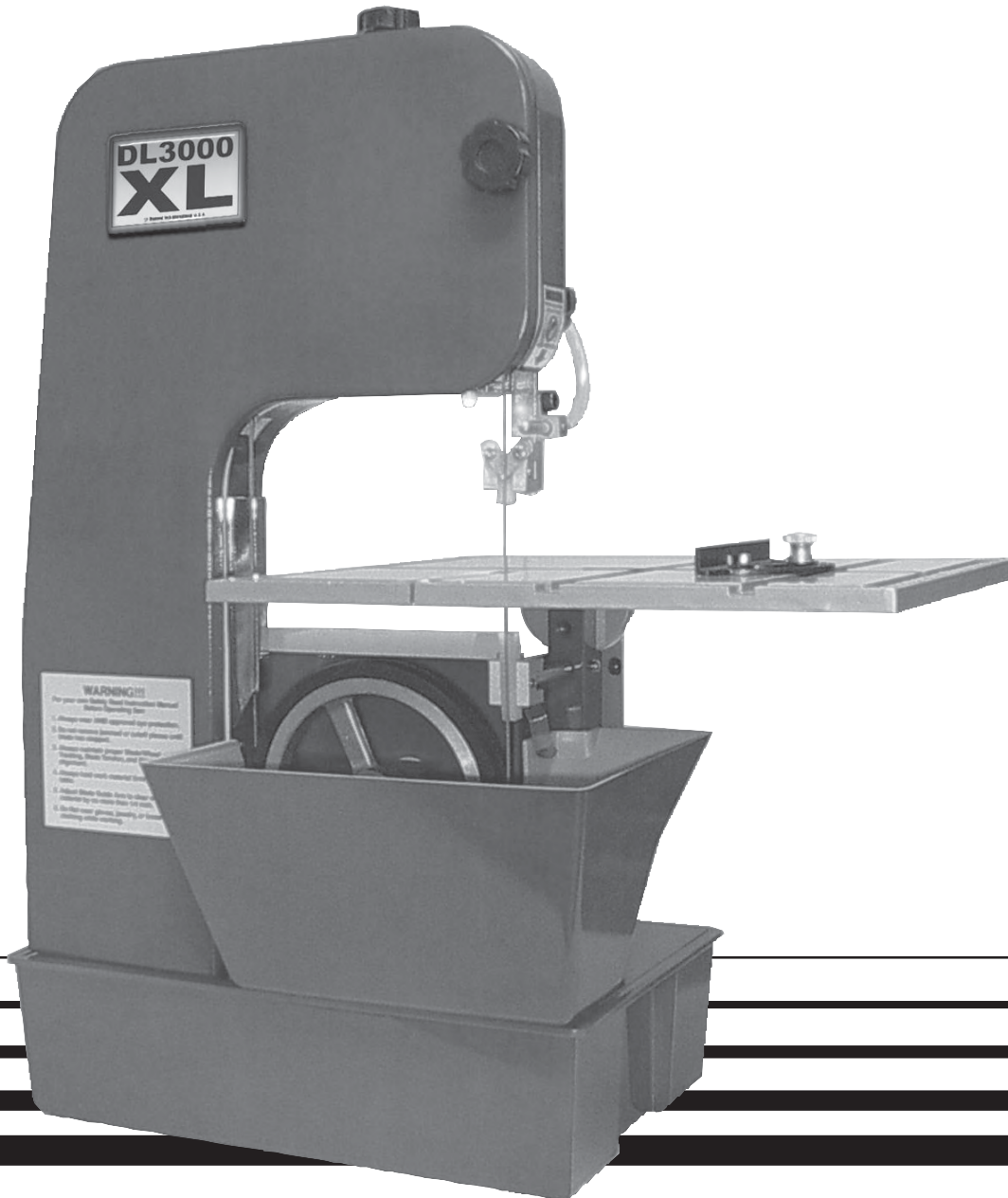

DL3000-XLTM
DIAMOND LASER BAND SAW

OPERATIONS MANUAL

Before You Begin

Read and follow all instructions carefully.

- After unpacking all components, assemble band saw on a firm level surface to prevent saw from tilting and rocking.
- Be sure the power switch is in the OFF position before plugging in the bandsaw.
- Always disconnect bandsaw from electrical outlet before setting up or servicing.
- Wear proper apparel. Never wear loose fitting clothes, neckties, jewelry and gloves that may get caught in moving parts.
- Remove all wrenches before using band saw. Leaving wrenches attached while operating this tool may result in damage to the machine and/or operator.
- Always wear safety goggles. Everyday eyeglasses have only impact resistant lenses; they are not safety glasses.
- Never turn on band saw while glass or working materials are touching the blade.
- Always hold material being cut firmly against cutting table.
- Feed materials at a slow easy pace into the blade. Avoid sudden twisting of the blade, which may cause kinking or breaking.
- Keep out of reach of children.
- Never leave saw running unattended. Turn power OFF when not in use.
- Do not operate while under the influence of medication or alcohol.
- To ensure top performance keep bandsaw properly maintained.

Contents

Your Diamond Laser 3000-XL™ has been shipped partially assembled. Carefully remove saw and parts from the packaging.

- 1- Band Saw Body
- 2- Cutting Table
- 3-"Ultra Plus" Filtration Reservoir
- 4- Recirculating Water Pump and Valve
- 5-Straight Edge/Angle Cutting Guide
- 6-Adjusting Wrenches
- 7-Extra Diamond Laser Band Saw Blade
- 8-Extra blade guides



Assembly Instructions

A. Table Installation

- 1) Remove table mounting bolt and washers from the table mounting block positioned directly behind the blade (Fig.1). Loosen and remove the table alignment screw located on the front of the cutting table blade slot (Fig.2).
- 2) While holding the table with the slot opening directly behind

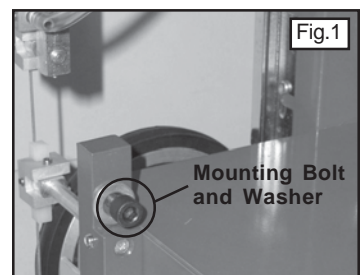

the blade, carefully slide the diamond blade through the slot.

- Secure cutting table to the mounting block with the table mounting bolt. Return alignment screw to the front of the cutting table and tighten.

B. Blade Installation

Blade comes preinstalled, however should it become loose in shipment or you need to replace a blade, follow these instructions.

- Turn power OFF. Open the band saw cover by loosening the knob on the front of the saw. The front panel will swing open, but can not be removed. Removal of lower wheel water basin may ease blade installation and adjustments.
- Loosen wheel securing knob, located at the rear of the band saw (Fig.3).
- Turn blade tensioning knob at the top of the saw counterclockwise (Fig.4). This will lower the upper wheel and allow the blade to loosen. It is not necessary to completely remove knob.
- Remove worn blade and install the new blade by centering it on the lower blade wheel (Fig.5), then on the upper blade wheel. If upper blade wheel is too high, lower by turning the blade tension knob counterclockwise (Fig.4).
- Ensure blade is centered on the blade guides. It should fit between the brass guides located on the upper guide block and in the middle groove of the lower blade guide (refer to *Blade Guide Adjustment-Section C* for further details).
- Tighten blade by turning blade tensioning knob clockwise (Refer to *Band Saw Use and Maintenance: Blade Tensioning - Section B* for further details).
- Once the blade is properly installed, retighten the wheel securing knob, located at the rear of the band saw (Fig.3). It may be necessary to loosen mounting bolt (Fig. 1) and adjust table position to recenter blade in the table opening.

WARNING: If the diamond blade is too loose, it can slip from the wheels. If stretched too tight, it could break.

C. Water Systems

The DL3000-XL comes equipped with a new durable recirculating water pump with an “ultra-plus” filtration system to keep your machine running clean.

- Place the “Ultra Plus” filtration reservoir on a solid level work surface, flat-side facing forward.
- Insert pump valve into the top of the recirculating water pump. Place pump in the left rear compartment of the “Ultra Plus” filtration reservoir (Fig.6).
- Place the saw body on top of the reservoir, with front sides flush.
- Connect the plastic tubing located on the back of the saw on to the pump valve. Plug pump’s electrical connector into the outlet adjacent to the fuse on the left side of the band saw (Fig.7).
- Fill the “Ultra Plus” reservoir with approximately 2” of water

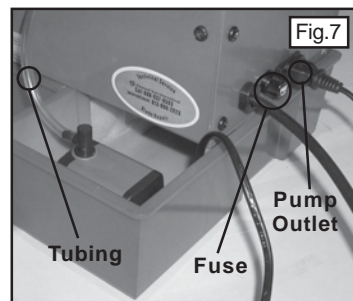
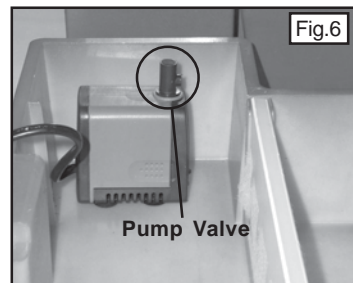
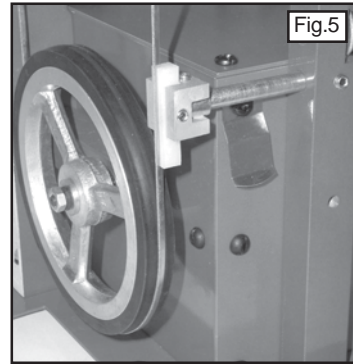
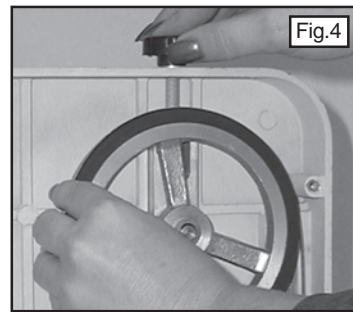
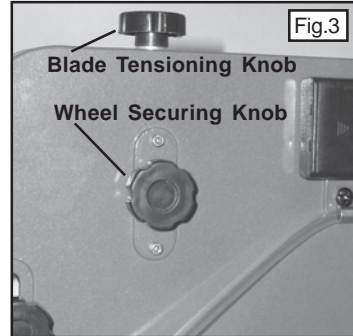
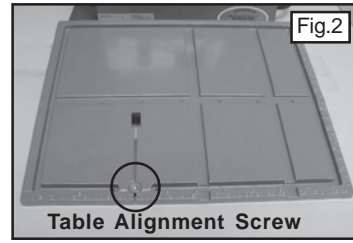

before use (Approximately 3 quarts of water).

- 6) To test pump, the saw must be turned on. Be sure the blade has been properly installed and there are no obstructions that may interfere with its operation and blade movement. DO NOT attempt to touch the blade or blade wheels while the machine is turned on.
- 7) Test pump and water flow by turning machine on at a slow speed and watch for bubbles in the hose. Water should begin to flow freely from the water nozzle mounted on the upper blade guide block assembly. Adjust position of nozzle so water flow is directed at the front of the blade, by loosening the set screw (fig.8).
- 8) If large pockets of air appear in the hose line, this may stop the flow of water to the blade. If this should occur, turn the saw off. Remove hose from pump nozzle without removing pump from water and let hose drain. Reattach hose and start saw again. Small air bubbles may persist in the line, but these will not interfere with sufficient flow to the blade.

WARNING: Never operate saw if there is insufficient water at the point of cutting, as this will cause damage to the blade.

D. Built-In Target Light

The DL3000-XL comes with a built in target light. Before operating, install 3 AA batteries.

- 1) Using your thumbs, slide battery door and lift the mounting case (Fig.9).
- 2) Install 3-AA batteries. Return battery pack to the mounting case.
- 3) Flip ON/OFF switch located on battery case to operate light.

E. Straight Edge/Angle Guide

- 1) For easy installation place guide in groove located on cutting table. Adjust guide location by removing the adjusting screw and moving guide to the various slots on the table top (Fig.10).

Band Saw Use and Maintenance

A. Drive Belt Tension Adjustment and Replacement

• Drive Belt Tension Adjustment

A loose drive belt may result in a noticeable loss of power to the blade wheels.

- 1) To tighten the drive belt, unplug the saw from the electrical outlet.
- 2) Remove cutting table by loosening and removing mounting bolt and washer.
- 3) Remove all screws securing the top and rear panels encasing the motor (fig.11).
- 4) Loosen both motor mount bolts using a large hex wrench (fig.12).

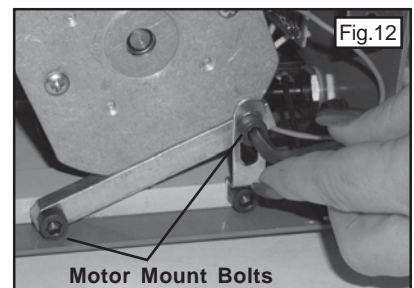
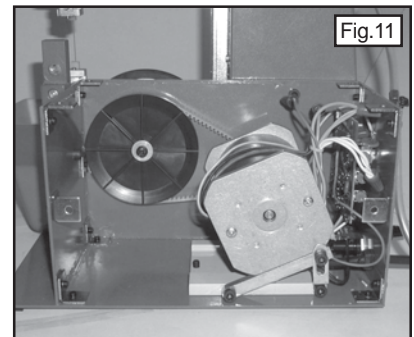
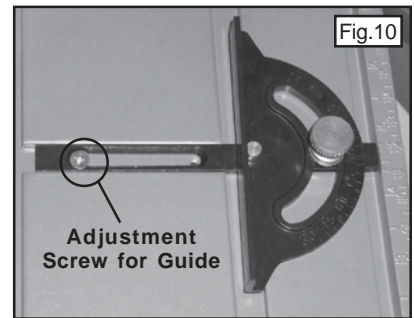
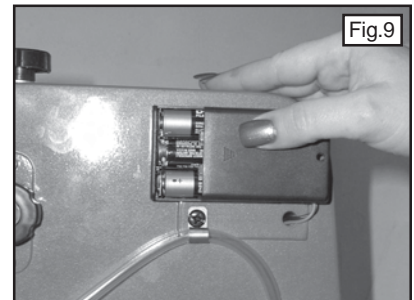
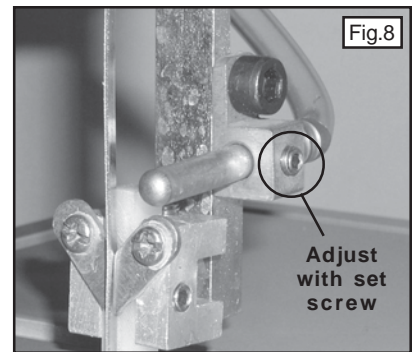

- 5) Press the motor downward to desired belt tension and secure into position by retightening the motor mount bolts. There should be moderate give in the belt tension (1/4" flex top and bottom).

WARNING: Do not overtighten belt. Overtightening the drive belt will slow the motor down and damage the motor. A loose belt will not turn the blade wheels properly.

• Drive Belt Replacement

- 1) To replace the drive belt, unplug the saw from the electrical outlet.
- 2) Remove cutting table by loosening and removing mounting bolt and washer.
- 3) Remove all screws securing the top and rear panel encasing the motor.
- 4) Remove water basin and lay saw face down. Remove left center screw that holds the motor plate into position. Loosen right motor mount screw slightly (Fig.13)
- 5) Pivot motor slightly to the right and drive belt will loosen and can be pulled off the motor and pulley wheel easily.
- 6) Replace drive belt by first wrapping it around the motor pulley. Then holding the belt over the pulley wheel, rotate it to the right coaxing the belt onto the pulley wheel from the bottom up (Fig.14).
- 7) Replace and tighten motor mount plate screws and adjust belt tension as needed.
- 8) Return the top and rear panels encasing the motor and faster with screws.
- 9) Replace cutting table

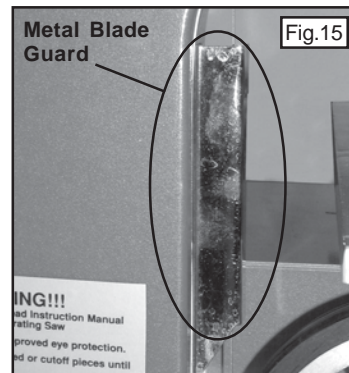
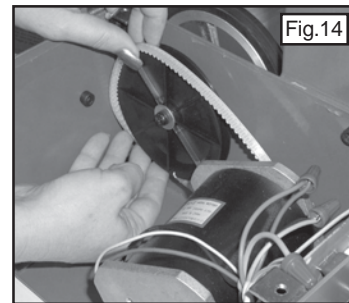
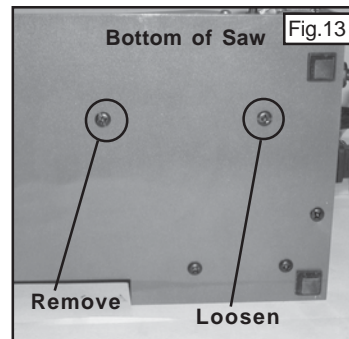

B. Blade Tension

To properly tension the blade, begin by slightly loosening the wheel securing knob behind the upper wheel. Turn on saw at slow speed and adjust the blade tensioning knob (Fig.3) until the metal blade guard (Fig.15) vibrates at a minimal rate. Continue to increase speed to maximum and adjust tension as needed. Then retighten the wheel securing knob.

WARNING: If the diamond blade is too tight, breakage could occur.

C. Blade Guide Adjustment

The DL3000-XL comes with lower and upper blade guides. Proper alignment of these guides are essential for proper glass cutting and extending blade life.

- 1) The upper blade guide (Fig.16) should be positioned slightly against the back of the blade. To adjust, use a small hex wrench and loosen the set screw located on the top of the blade guide block. Slide the blade guide block backward or forward to achieve proper position.
- 2) The blade should fit directly between the brass wing guides, located on the front of the upper blade guide block (Fig.17). These help stabilize the blade to prevent it from twisting.
- 3) The blade should pass through the lower blade guide block with the back edge of the blade resting slightly against the

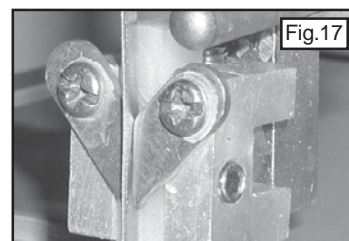
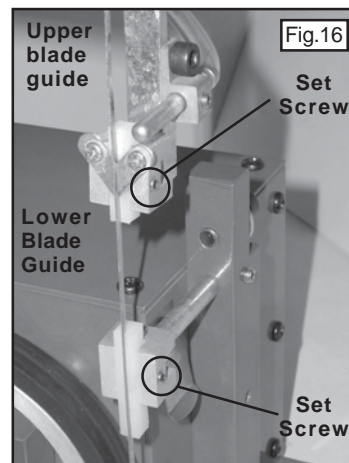

deepest part of this channel. To adjust, loosen the set screws located on the lower blade guide mounting block and slide blade guide arm back and forward to adjust properly (Fig.16).
NOTE: Blade guides and blade tension should be adjusted after approximately 3 hours of use. Frequent replacement of blade guides is recommended to maintain cutting accuracy and extend blade life.

D. Upper Blade Guide Adjustment

The position of the upper guide should be 1/4" from the top of the material you are cutting.

To adjust height of blade guide, loosen guide tension knob on back of saw and raise or lower the guide assembly (Fig. 18). If the guide does not go low enough, unscrew the knob completely and reinsert into upper hole on bar and retighten. This adjustment should allow you to lower the guide positioning even further.

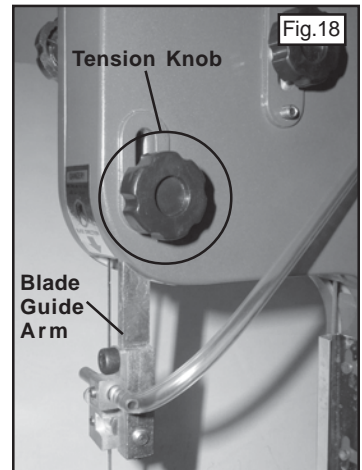

E. Straight Edge / Angle Guide

The band saw is designed for intricate radius cuts, however the straight edge guide will permit moderate straight edge or fixed angle cutting when needed. Place work material against the straight edge guide and feed the material slowly.

F. Ultra-Plus Filtration System

The "Ultra Plus" filtration system consists of 2 removable water filters. These filters need to be cleaned periodically depending on saw usage. To clean, simply remove pump, lift saw from tray and remove filters. Run filters under cool water until water runs clean. Reinsert filter back into the tray, replace saw on the tray and refill with cold water (Fig.19). Also rinse reservoir of all grit residue.

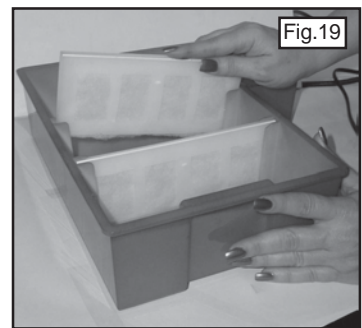

G. Blade Tracking

The top and bottom wheels of your DL3000-XL are constructed with a feature that permits wheel tilting adjustments if necessary. The blade is properly aligned when it rides on the center raised portion of the wheels.

1. Upper Wheel Tracking Adjustment

Run saw at minimal speed. Slightly loosen the wheel securing knob. Locate the two set screws above and below the wheel securing knob (Fig. 20). Using a small hex wrench tighten top set screw to bring upper wheel forward. Tighten bottom set screw to bring upper wheel backward. Adjust until blade runs centered on the guide wheel.

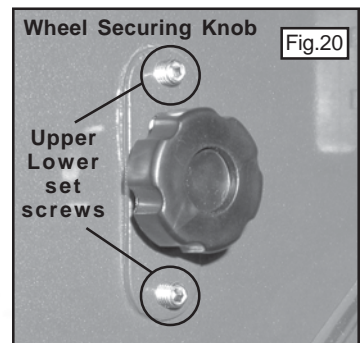
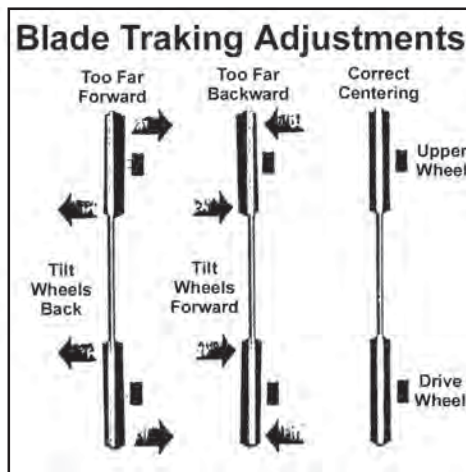

2. Lower Wheel Tracking Adjustment

Run saw at minimal speed. Open front panel of saw. Locate the set screw parallel to the lower wheel (Fig.21). Using a small hex

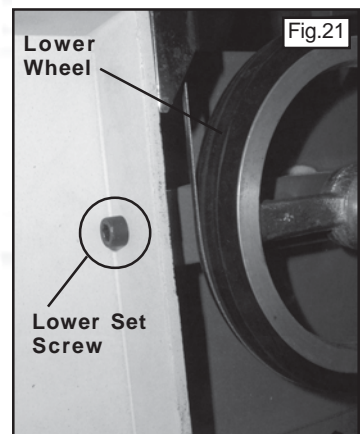

wrench loosen set screw. Please note, when set screw is loosened, the arm and the wheel will move as a unit. Move forward to position blade to the back of the wheel; move backward to position to the front of the wheel. Once blade is centered on the lower wheel, tighten set screw and close front of saw.

Quick Tips

- 1) When cutting materials, the highest blade speed will usually result in fast and smooth cutting. Use a slower speed when working with delicate materials or making very tight turning radius.
- 2) Do not force materials into the blade. Ease the materials into the blade, turning as you go to create your pattern. Avoid twisting the blade on tight curves.
- 3) To back out of a cut, turn the saw off and ease the material away from the blade.
- 4) Clean band saw after each use with lukewarm water. If using the recirculating pump, run clean water through pump until it runs clear and the water tube appears clean.
- 5) When not in use, loosen blade wheel tension. When storing for extended periods, remove blade and drive belt, then store.
- 6) Use a waterproof pen to mark your pattern on material. For added protection allow the ink to dry and use a Chap Stick over line before cutting.
- 7) Two or more pieces may be cut at the same time by stacking them together and using “tacky wax” or double sided tape to hold glass in place. If using glue or tape, clean blade after use by running a clean piece of glass or tile through blade.

Troubleshooting

Problem: Work material becomes jammed.

Cause: Twisted blade from forcing work materials into the blade.

Solution: Before freeing any jammed materials, turn OFF power switch and wait until all moving parts have stopped. Open saw casing door and rotate the top wheel counter clockwise until blade is freed from work material. Gently free work material, holding blade against the blade guides to prevent it from stretching or badly twisting. Inspect blade for kinks and ensure there is no remaining debris in the blade path which may have caused the jam.

Problem: Saw runs slowly or stops while cutting

Cause 1: Drive belt slippage.

Solution 1: See Band Saw Use and Maintenance Drive Belt Tension-Section A.

Cause 2: Blade is “gummed-up” due to cutting soft materials or tape.

Solution 2: Cut several inches of clear window glass, this will clean the residue off the blade surface.

Additional Parts

Item	Item Number
DL3000-XL DRIVE BELT	P907
DL3000-XL BLADE GUIDES	DL3270
DL3000-XL STAINLESS STEEL BLADE	DL3220
DL3000-XL WOOD BLADE	WB0450
DL3000-XL SCRATCH MAT	DL0232

Blade Repair Service

DTI offers a blade repair service should a blade break with ample diamond remaining. Return blade, indicating saw model and payment to *Diamond Tech International, Blade Repair Service, 5600-C Airport Blvd., Tampa, FL 33634*. For International and special handling, please include extra postage and shipping instructions

Blade Repair Fees (U.S. Dollars):

Speedster, DL1000, DL3000.....	\$25.00
DL5000.....	\$45.00

Diamond Tech International

Diamond Laser Series 3 Year Warranty

All *Diamond Tech International* band saws and accessories are manufactured to high quality standards and are serviced by highly qualified technicians. To obtain additional information regarding our products, parts, service or warranty assistance, please call toll-free 800-937-9593.

The **Diamond Laser 3000-XL** is warranted to the original purchaser for three full years from the original purchase date. During the three year period, a defective **DL3000-XL** will be repaired or replaced when the machine is returned, prepaid to *Diamond Tech International*. If the **DL3000-XL** suffers damage due to customer modifications and/or is used for any application other than that for which it was designed, this warranty is void. The **DL3000-XL** is warranted against defective materials or workmanship. This warranty does not include damage due to: (A) neglect (B) accident (C) unreasonable use (D) improper maintenance (E) any other causes not attributed to defects in material or workmanship. This warranty specifically excludes the Diamond Laser Stainless Steel Blade and Blade Guide Sets. Any implied or otherwise explicit guarantees made through merchandiser of this product are not covered in this warranty coverage agreement and are expressly disclaimed.

IMPORTANT NOTE: This machine was designed for certain applications only. *Diamond Tech International* strongly recommends that this machine NOT be modified and/or used for any application other than that for which it was designed. If you have any questions relative to its application, please contact us and we will advise as to its proper use.

DIAMOND TECH INTERNATIONAL, USA

5600-C Airport Blvd., Tampa, Florida 33634
Tech Support: 800-937-9593 (U.S.A., Canada) 813-806-2923 (International)
Fax: 813-806-1988, Email: dti@digital.net
www.dticrafts.com

2/2002